

MOBELI®

ROTH Sanitärprogramme GmbH
Kohlbergstraße 5
D-72213 Altensteig
Tel +49 (0)7453/9381-0 Fax -23
info@mobeli.de
www.mobeli.de

QuattroPower Bath Tub Grab Handles with Vacuum Safety Indicator

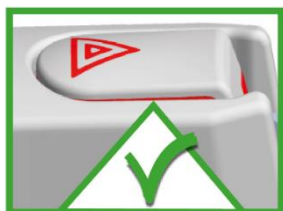

CE



EN

Instruction Manual
QuattroPower Tub

REF

1400261S, 1400262S, 1400263S, 1400264S



Table of contents

1. General	2
1.1 General information	2
1.2 Explanations/symbols in the manual and on the handle	3
1.3 Intended use	3
1.4 Application range of the product	3
1.5 For your information	3
1.6 Useful life	4
1.7 Reuse	4
2. Safety information	4
3. Operation / mounting	4
3.1 Mounting / assembling	4
3.2 Attaching / suction	4
3.3 Releasing	5
3.4 Disassembling	5
4. Technical data	6
4.1 Markings on the product	6
4.2 Table of technical data	6
4.3 Materials	6
5. Maintenance	6
5.1 Maintenance (cleaning/disinfection)	6
5.2 Maintenance (service)	7
6. Recognizing and remedying malfunctions	7
7. Disposal	7
8. Pictures for operation	8
8.1 Pictures for operation – mounting/assembly	8 and 9
8.2 Pictures for operation – mounting/disassembly	10
8.3 Images of the function of the vacuum safety indicator	11
9. Accessories	12

1. General











1.1 General information

Please read this manual carefully before use and follow the safety instructions to ensure your safety when using the mobile QuattroPower bath tub grab handle. Keep these instructions for future reference and pass them on to other users!

If the safety rules stated in the instructions for use are not observed, any liability on our part is excluded.

1.2 Explanations/symbols in this manual and on the handle

	Follow the instructions for use!
	For persons with visual impairment, the font size for this on-line manual can be set accordingly at https://www.mobeli.de/download-bereich .
	Warning (indicates a dangerous situation)
	Manufacturer (additionally, year of manufacture on the handlebar)
	Order number
	Maximum user weight
	The mobile MOBELI grab handles comply with the directive 93/42/EEC on medical devices of class I.
	Batch designation



Allergy Notice: The high-quality rubber discs contain natural rubber latex. Natural rubber latex can cause allergic reactions including anaphylactic reactions.

1.3 Intended use



As grab handle or stand-up handle for adults and children. The mobile bath tub grab handles have been developed to support natural movement. **They are not designed to carry the full body weight.**

Any other use, e.g. as a seat, carrying handle or climbing aid, is not permitted.

1.4 Application range of the product

The bath tub grab handle is intended for largely independent use indoors at bath tubs.



For the vacuum suction generated by the rubber pads to be effective, **the support handle may only be attached** to smooth and non-porous rigid surfaces that are pore- and steam-tight, clean, dry, and free of oils and grease.

On rough or porous surfaces, the vacuum hold will be diminished or does not exist at all. Please bear in mind that tiles are not necessarily always smooth and steam-tight (i.e., suitable for vacuum generation).



Test your tiles and the wall prior to use (with the help of another person, if necessary).

Since the vacuum suction pads are made from strongly adhesive and flexible natural rubber, they can usually adapt to slightly textured tiles. (Attention, reduced holding time! Pay attention to the safety indicator!)

The mobile bath tub grab handle is ideally suited for use at home where there are no permanently fixed handles, e.g. for short-term use after a stay in hospital or for testing of a new accommodation. It is also well suited at hospitals and nursing homes as an additional and short-term supplement for stationary support handles.

The mobile support handle can be used as an entry and exit aid for a built-in or free-standing bath tub. It can be attached to the outside of the bath tub (please check strength beforehand) or inside the tub.

1.5 For your information

In hotels and public establishments in Europe, tiles must be non-porous and steam-tight (as per DIN/EN 159 and 176). According to the tile adhesives material standard DIN EN 12004, tile adhesives must have a minimum adhesive strength of 0.5 N/mm². E.g., for two tiles with a tile size of 147 mm x 147 mm x 0.05 kg/mm², this would result in an adhesive strength of approx. 2,160 kg. Even with an effective adhesive surface of only 1/3 of the tile surface (e.g., due to a rough serrated trowel) and tile joints not filled-in, there would still be an adhesive strength of approx. 700 kg.

Unfortunately, though, one cannot always rely on this assumption; therefore, it is absolutely indispensable to test the adhesive strength of the respective tiles or other surface materials on the wall beforehand.

Furthermore, due to material ageing or in prefabricated construction there might be a reduction of the adhesive strength, therefore testing is essential (e.g., by abrupt application of force; with the help of another person, if necessary).

1.6 Useful life

The expected useful life is six years (if used daily and in accordance with the intended purpose) in an institution or public facility. The prerequisite for this is compliance with the maintenance and safety regulations specified in these operating instructions. The actual service life may vary depending on the frequency and intensity of use. These handles have been tested according to ISO 17966:2016.

1.7 Reuse

The product is suitable for repeated use. How often the product can be used depends on the type of use. Clean and disinfect the product thoroughly before re-use and check the handle carefully, especially the function of the vacuum safety indicator.

2. Safety information



- **Prior to any use of the mobile bath tub grab bar, the vacuum safety indicator must be examined and acted upon according to the instructions (cf. page 10)**



- **Even on fully impermeable, flush tiles it can never be determined exactly when the vacuum will decrease (e.g. due to hairline cracks), therefore always pay attention to the vacuum safety indicator!**
- Use the mobile bath tub grab handle only when you have experience in handling it or while you are under supervision of a person who has experience in its use. Children may only use the handle under supervision or if you have secured the rocker arms with a rocker arm lock (cf. accessories on page 11).
- Before each new attachment, make sure of the proper functioning of the mobile bath tub grab handle. Pay particular attention to the rubber suction pads; they must be clean and undamaged and must not show any signs of tearing or scoring.



Never use mobile bath tub grab handles with damaged rubber pads and/or with reduced adhesive strength.

- Remember that the suction cup only adheres as well as the substrate, so check the adhesion of the substrate (e.g. the tile on the wall and the bath tub) before using the grab handle in a new location.
- After applying the vacuum tilting levers, the sucking adhesive strength created by the vacuum can be entirely or partly absent, in particular with unglazed tiles, natural stone (marble), wood, as well as ceramic coating that has been textured/grinded or given a rough grain to provide a non-slip finish.
With handles with vacuum safety indicator this becomes visible by the rising of the flip-up tab!
- **Attention!** Usage under water reduces the holding strength.
- The holding strength stated above refers to normal room temperature (10 °C – 30 °C); at high temperatures, e.g. in a sauna, the holding strength will be reduced. **Attention!** Temperatures higher than 41 °C can be reached due to solar radiation or by contact with hot water which can lead to skin damage and/or burning.
- The indicated holding strength is calculated at about 300 m above sea level. At higher altitudes, the holding strength diminishes (by approx. 10 % per every additional 1,000 m of altitude).
- Never expose the rubber pads to UV radiation (sunlight) for any prolonged periods of time; otherwise they will quickly lose their elasticity. For this reason, never attach the bath tub grab handles to any window pane that will be illuminated from the outside.
- Do not place anything underneath the grab handle that could be damaged by the handle suddenly releasing and dropping on it, or remove the handle after use.
- **The mobile bath tub grab handles may only be used with the tilting levers perfectly engaged.**
- Do not attach the mobile bath tub grab handles to vehicle metal panels, foils, or thin glass panes because the vacuum created by the suction pad might deform and damage these materials.
- If the mobile bath tub grab handle remains attached over prolonged periods of time, there is the risk that the underground (e.g. bath tub) gets permanently stained by the rubber pad.
- Never combine MOBELI products with parts from other manufacturers. This will invalidate any warranty or liability. **Risk of accident!!!**



3. Operation / assembly

3.1 Mounting (see page 8)

(Fig. 1) Push in the snap-lock pins from the bar connector (B) and insert into the short bar (C) until the snap-lock pin engages in the hole. (Fig. 2 arrow) Then insert the long bar (part D) into the bar connector (B). Insert the two bars (C and D) into the suction head connectors (A) (fig. 3).



**Test the secure hold of the snap-lock pins by trying to pull the components apart!
The handle must not be used if not all snap-lock pins on both sides are securely locked.**

3.2 Attaching / suction: (see pages 10 and 11)

1. Examine the vacuum suction pads and the surface they are to be attached to.
2. Clean the surface thoroughly (fig. 11) so that it is **clean** (e.g. from etched lime sludge) and **grease-free**. Likewise, the surface of the suction disc must be clean.
3. **Firmly press the upper suction heads of the support handle onto the surface where they should be sucked on.** (Fig. 13).
 - a. The **tilting vacuum levers** must be **loose** at this point.
 - b. Take care that both rubber pads are always positioned with their **full suction area** on the tiles or other surfaces so that no grouting line or tile joint lies under a rubber pad and the pads are attached at least 10 mm above the lower edge of a joint (fig. 12).
4. While **pressing the handle against the surface to be adhered to and at the same time pressing on the rocker**, turn over the 1st rocker and then the 2nd rocker (figs. 13, 15, 16, 17, 18).
5. Attach the lower suction heads (fig. 14); when doing so, you must turn the suction heads in such a way (see arrow) that they are flat on the wall (**you have to apply some force due to the built-in safety brakes**).
6. The vacuum safety indicators continuously monitor the current vacuum state.

After the rockers have been pressed and turned, all the red-coloured safety tabs must be **completely recessed flush with the surface** in the rockers (page 11, figs. 19 and 21)! In the course of time when the vacuum decreases, the safety rockers will extend.

- If a red side edge of the safety tabs (figs. 20 and 22) has become visible, the grab bar must not be used under any circumstances and **must be reattached** immediately!

- **The clearer a red side edge of the tabs** (figs. 20 and 22) **can be seen, the lower is the actual adhesive strength!**

7. Check the vacuum safety indicator prior to any use. This can be felt by visually impaired or blind people. If the vacuum safety indicator is not retracted (as just described), reattach the suction pads. If the indicator tabs are still raised after the rocker has been turned and also are still sticking out after the tabs have been pressed, the grab bar must be reattached (cf. malfunctions on page 7).

If retraction of the indicator tabs cannot be achieved, do not use the handle under any circumstances!

3.3 Releasing:

1. Put a finger under the vacuum tilting lever in order to raise it; at the same time set your thumb on the structured recess of the vacuum tilting lever to prevent a recoil effect. **Caution! With wrong operation there exists danger of squeezing.**
2. Wait a little while! The rubber pads will relax after approx. 30–60 seconds and return to their original shape, and then the suction device can be removed from the wall. Should the rubber pads keep adhering longer, you can additionally raise the pads at one side (between wall and rubber disc) with a finger so that air can penetrate underneath.
3. **Do not try to loosen the rubber pads with sharp edged items or tools; you would damage them.**
4. When not in use, store the mobile support handle with the rubber pads relaxed (i.e., with tilting levers disengaged), flat and plane. Protect your mobile support handle (e.g. in the box) from UV rays.

3.4 Disassembling (see pages 8 and 9)

Push in the snap-lock pins of the bars with the included push-in aid (**without** the red part) and pull the bars out of the suction head connector while firmly holding it (figs. 5 and 6).

Push in the snap-lock pins (fig. 7 see arrows) with the included push-in aid (**with** the red part) and pull the bars out of the bar connector while firmly holding it (fig. 8).

Disassembling the bar connectors and suction parts:

Push in the snap-lock pins (fig. 9) of the suction head connector with the included push-in aid (**without** the red part) and pull the suction head connector out of the suction casing while firmly holding it (fig. 10).

When using other implements than the push-in aid there is a risk that you press the snap-lock pins out of their guides!

(You can assemble two grips out of the disassembled QuattroPower bath tub grip; compare figs. 4 and 7 or our video.)

4. Technical data

4.1 Markings on the product: (For explanations of the symbols, see page 2)

Below on the short grab bar    14002 61S / 62S    max. 80 kg 

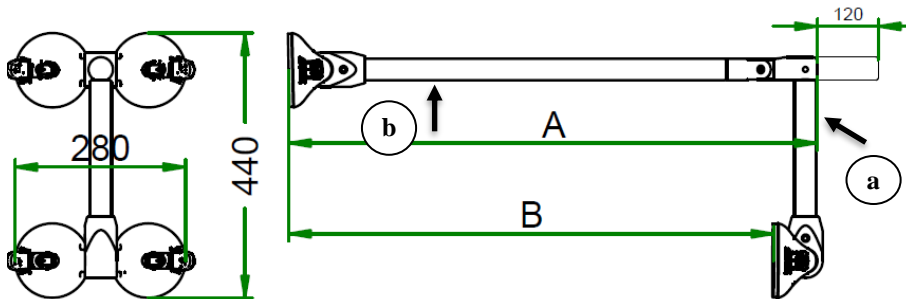

Above on the long grab bar     ROTH GmbH D-72213 Altensteig 2018   MOBELI.de QuattroPower 



Thanks to the Mobeli modular system, the additional handle extension of 120 mm can also be retrofitted. Order nos. 1400261S and 1400263S refer to the model without and order nos. 1400262S and 1400264S refer to the model with handle extension.

 **Maximum user weights in the table of technical data and on the handle bar must be observed! The mobile bath tub support handles have been developed to support natural movement. They are not designed to carry the full body weight**

4.2 Table of technical data

 ROTH order no.	A in mm	B in mm	Width C in mm	Grip Ø in mm	 Max. user weight in kg	Grip weight in kg
14002 61S	860	790	280	35	80	3.0
14002 62S	860 + 120	790	280	35	80	3.2
14002 63S	740	670	280	35	80	2.9
14002 64S	740 + 120	670	280	35	80	3.1

4.3 Materials:

Handle bar made of high-impact PVC, all metal parts made of stainless steel
Suction disc made of NBR, suction casing made of PA 6.6

5. Maintenance

5.1 Maintenance (cleaning/disinfection):

- Clean the bath tub handle with a cloth using standard household detergents such as soapy water, but do not use abrasive or aggressive cleaning agents. Do not use thinner or petrol and do not use detergents that attack plastics.
- Rinse the bath tub handle thoroughly with warm water until all soap and foam residues have been removed. (Otherwise rust can adhere to the stainless-steel parts.)
- Keep the rubber pads always free from dust and dirt by rinsing them with warm water and then drying with a lint-free cloth.
- A basic cleaning with our special cleaner (order no. 1400677) or isopropyl alcohol will increase the suction effect and is recommended in larger time intervals (dependent on the frequency and conditions of use, e.g. after use of bath additives containing oil).
Use these cleaning agents only on the rubber pads but never on the plastic parts.
- Disinfect the product by wiping all surfaces with a cloth with disinfectant.
- In a medical environment, also refer to the "Recommendations of the Commission for Hospital Hygiene and Infection Prevention" on the website of the Robert Koch Institute www.rki.de.
- The bath tub grab handle is resistant to the active agents in the hand and surface disinfectants certified by the DGHM (Disinfection Commission of the German Society for Hygiene and Microbiology) with the exception of phenol ether, pyridine derivative, and thiocyanate.
- **Only alcoholic disinfection without re-fattening component may be used on the rubber discs.**

5.2 Maintenance (service):

- If the handle has been attached to the wall for a prolonged period of time, the rubber discs will overstretch. We therefore recommend that you remove the handle from the wall approx. every 14 days and leave it overnight on a flat surface with the rubber disks relaxed, then reattach it the next morning.
- Examine the rubber pads for possible functional deterioration because of reduced elasticity due to age, wear, exposure to sunlight, uneven storage, scoring, etc.
If the rubber pads are damaged and therefore the adhesive strength is limited, the complete suction heads (spare part no. 14002S) are to be replaced or the rubber pads (spare part no. 1402721) must be exchanged by trained specialist staff.
- Keep the vacuum safety indicator always free from dirt!!
- **Check the handle regularly for damage and do not use the handle under any circumstances if it is damaged.**



6. Recognizing and remedying malfunctions

Malfunctions	Possible causes of malfunctions/test	Corrective measures
With new handle: safety indicator pops up after a short time	Lime or other dirt on the surface.	Clean the surface thoroughly.
	The surface is not non-porous even if it looks smooth, or it is damaged (e.g. hairline crack in the tile). Possible test procedure: Attach the handle to a glass pane or mirror and pay attention to the safety indicator. If now the safety indicator does not move any more, the fault is in the substrate.	If possible, attach the handle at another location where the underground is non-porous. If this is not possible, self-adhesive stainless-steel plates (order no. 1461418) to which the handles can be attached can be glued on. See accessories.
With older handle: safety indicator pops up after a short time	Rubber discs scratched or damaged.	If there is damage, the rubber discs (order no. 1402721) can be replaced by a specialist dealer or the complete suction head (order no. 14002S) can be replaced.
Indicator rocker is still slightly raised after mounting	1. Toggle lever not firmly pressed down before turning over!	Attach the handle again while beforehand pressing the rocker arm firmly down. (Page 8 fig. 3 arrow 2)
	2. The rubber pad is overstretched. This happens when the handle has been attached to the wall for a long time.	Store the handle overnight on a flat surface with the rocker arm pointing upwards. Attach again the next day while beforehand pressing the rocker arm firmly down. If the mounting rocker still protrudes after pressing it in, the rubber discs (order no. 1402721) must be replaced by a specialist dealer or the complete suction head (order no. 14002S) must be replaced.
The suction heads cannot be pressed flat against the wall.	The built-in safety brakes prevent the suction heads from rotating.	With sufficient force, the suction heads can be adjusted correctly (page 10 fig. 13 and 14). If this is not possible to do for you alone, please ask a specialist to help you.
The snap-lock pin has fallen out.	The snap-lock pins (pages 8 and 9 figs. 4 and 7) have been pressed in without the red additional part. Another object that was too long was used to unlock.	The snap-lock pins can be quickly reinstalled by a specialist using a tool. If these are lost, individual parts can also be reordered.

7. Disposal:

The product packaging should be recycled. The metal parts can be recycled as scrap metal. Disposal must be carried out according to the respective national statutory regulations. Please ask your local or communal authority about local disposal facilities.

These ROTH mobile grab handles may not be exported to the U.S. (cf. U.S. version).

Subject to technical modification.

8. Pictures for operation

8.1 Pictures for operation mounting / disassembly

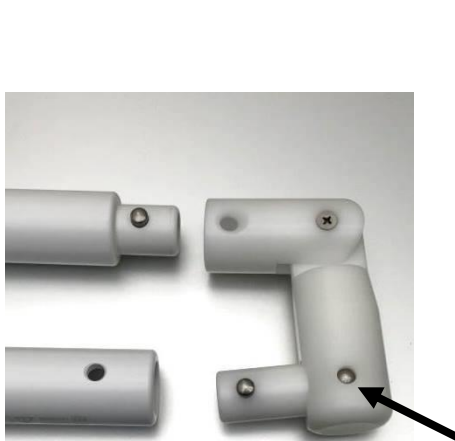
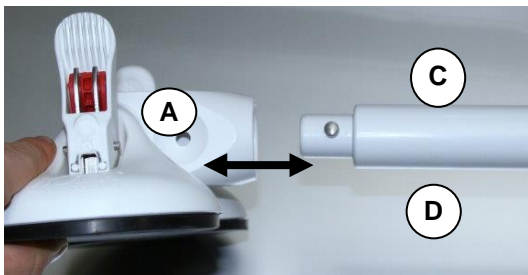
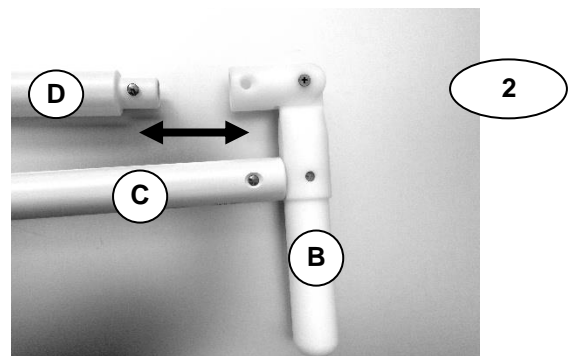
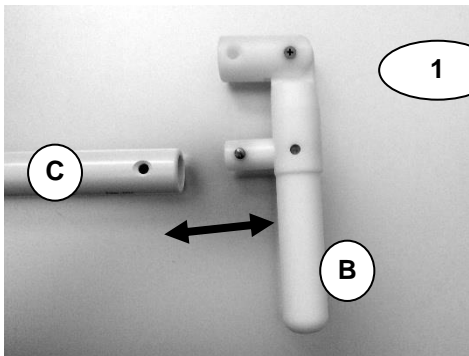
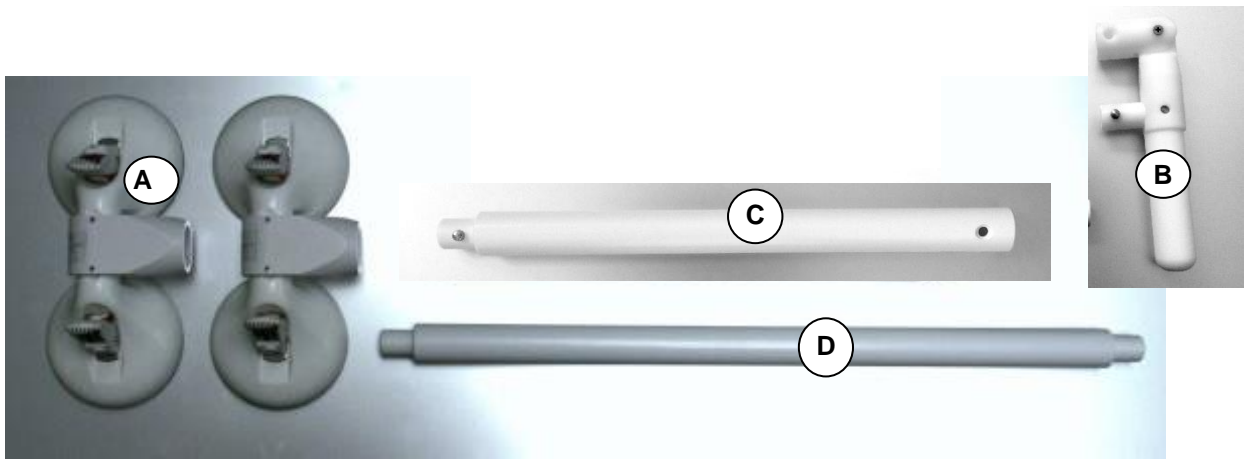

4



Video –
Disassembling QuattroPower

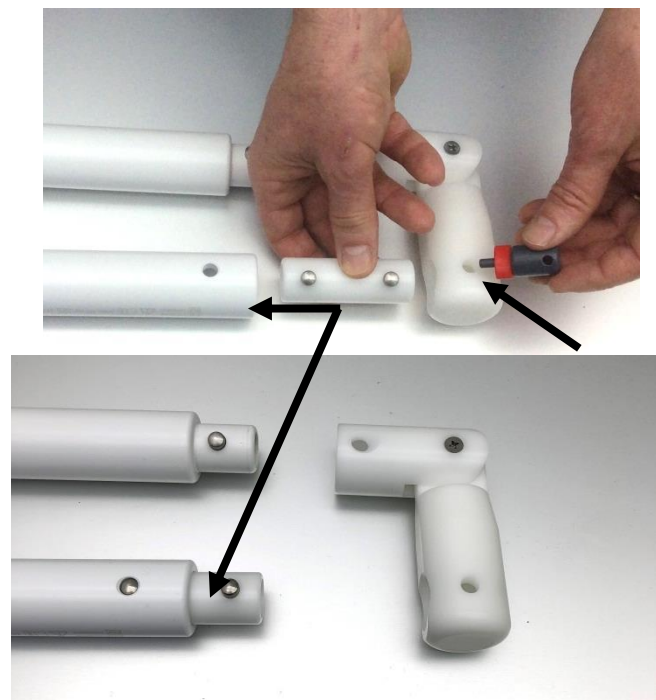

8.1 Pictures for operation mounting / disassembly

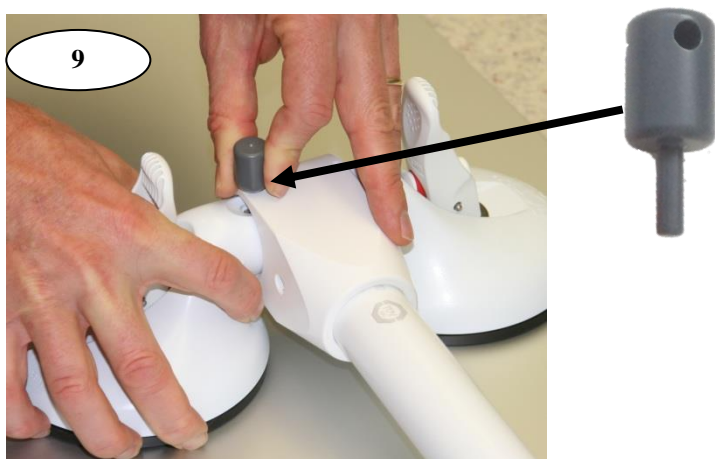
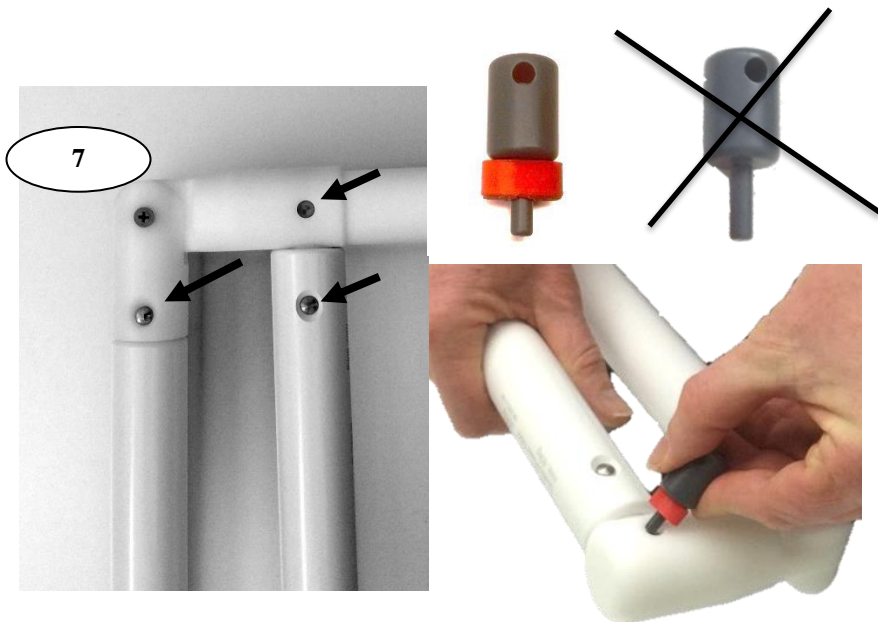
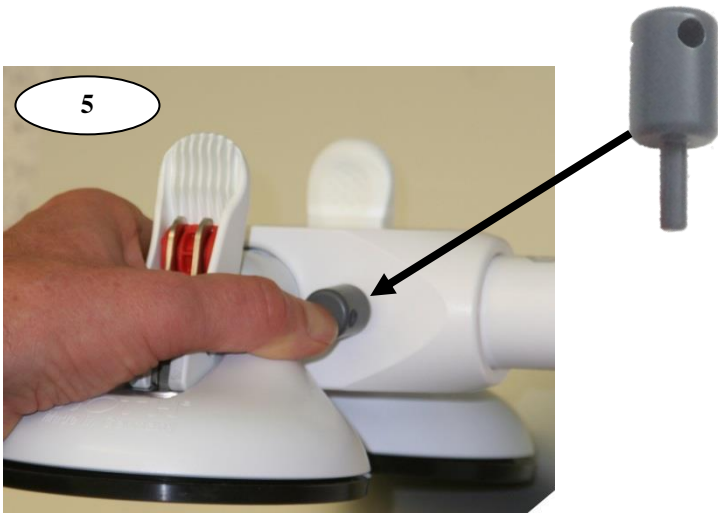

8.2 Pictures for operation assembly



min. 10 mm!

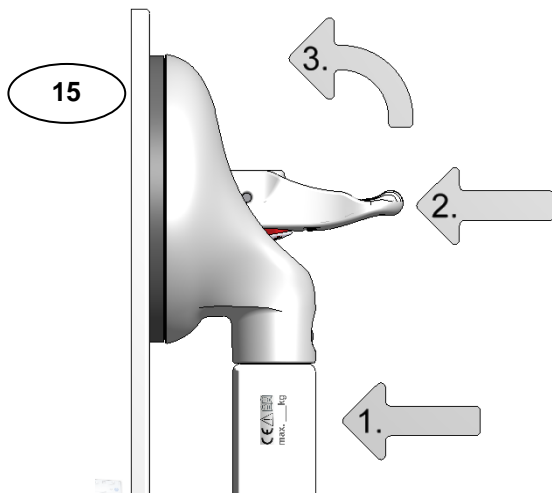

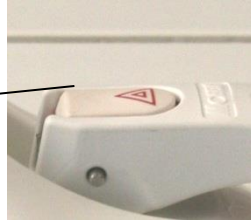

Correct!



Adhesive strength too low!
Suction head must be reattached immediately.
Risk of accidents!

Mode of operation of the safety rocker: The vacuum is permanently monitored!

Explanation of the symbols on the grab handles:

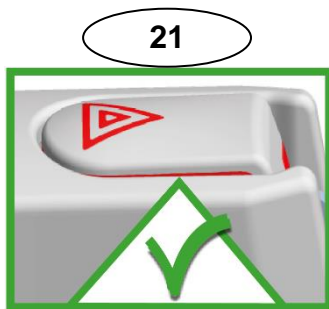

Full security for the specified maximum user weight.

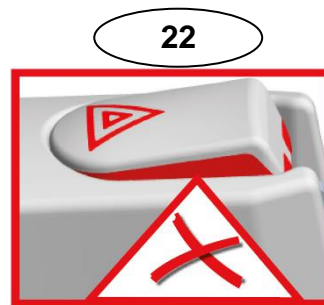

Attention! The handle must be reattached immediately!

The vacuum of the handle is reduced.
The handle is no longer permissible for the maximum user weight.
(Only for your information: A reduced adhesive strength is still present.)

9. Accessories

Accessories are available from your specialist dealer.

To prevent unauthorised persons (e.g. demented persons, children, or in public areas) from opening the handle, we recommend our rocker arm safety lock.

REF 1400674 (for 4 locks and 1 key).

Video – Tilting lever lock



Flexible contrast rings
Stainless-steel plates

Order no. 1402766, for better contrast for visually impaired persons
Order no. 1461418, for non-porous tiles

Video –
Quattro in bath tub



Should you require further information and videos about the products, please contact us.

You can also find them on our website:

www.mobeli.de

The instructions for use are available in the download area:

www.mobeli.de/download-bereich

A brand of:



MOBELI®

ROTH Sanitärprogramme GmbH
Kohlbergstraße 5
D-72213 Altensteig
Tel +49 (0)7453/9381-0 Fax -23
info@mobeli.de
www.mobeli.de